

Removing Clausal Determiners in Kwa

Sampson Korsah & Andrew Murphy*

Abstract

This paper argues that the distribution of the clausal determiner in two Kwa languages, Akan and Gã, is best captured by appealing to Structure Removal. The clausal determiner is found in various, heterogeneous environments that seem difficult to unify as a natural class. However, we argue that they instantiate the contexts in which an underlying DP shell on a clause fails to be removed in the derivation. This approach captures the distribution of the clausal determiner in both languages and is compatible with additional facts about coordination. Some cross-linguistic implications of this analysis will also be discussed.

1. Introduction

The category of clausal constituents has been a topic of interest since the onset of generative grammar (e.g. Lees 1960, Rosenbaum 1967, Ross 1967, Kiparsky & Kiparsky 1970, Perlmutter & Soames 1979). While the existence of clausal constituents have motivated category-specific labels such as S and C(P), it has been noticed that clauses show a number of nominal properties, leading some to suggest that they are of the category D.

We can identify two stands of research in the literature that exemplify this. First, many have argued that sentential subjects are nominal in nature (e.g. Lees 1960, Rosenbaum 1967, Ross 1967, Delahunty 1983, Davies & Dubinsky 1998, 2009, Han 2005, Hartman 2012, Halpert & Schueler 2013, Lohndal 2014, Knyazev 2016). In practice, this means that CPs are contained in an outer DP shell that allows them to appear in argument positions (1).

(1) [DP [CP That John will win]] seems likely.

* For comments at various stages of this work, we would like to thank audiences at *SelectionFest* at ZAS Berlin, GLOW 41 in Budapest, as well as audiences at Leipzig University and Queen Mary University London. Particular thanks go to Klaus Abels, David Adger, Hagit Borer, Benjamin Bruening, Emily Hanink, Itamar Kastner, Idan Landau, Fabian Heck, Gereon Müller, Coppe van Urk, among others, for discussion.

Beyond this, empirical arguments have been put forward in support of this view of sentential subjects as DPs. For example, McCloskey (1991) points out that clauses seem to be specified for (singular) φ -features. This can be seen by the fact that conjoined clauses trigger plural agreement of the verb, as well as licensing averbs such as *equally* (2).

(2) *Sentential subjects have φ -features* (McCloskey 1991:564):

[_{DP} That the president will be reelected] and [_{DP} that he will be impeached]
are **equally** likely at this point.

Furthermore, clausal arguments seem to need Case licensing (Vergnaud 1977/2008). As (3a) shows, sentential subjects cannot be merged in non-Case positions such as the subject position of a raising infinitive, just like ordinary argument DPs (also see Müller & Sternefeld 1995:48 for data from German). In ECM-infinitives (3b), on other hand, sentential subjects are much more acceptable, due to this being a Case position.

(3) *Sentential subjects need Case* (cf. Bošković 1995:33):

- a. *It is likely [_{TP} [_{CP} that John loves Mary] to be surprising]
- b. ?I find [_{TP} [_{DP} [_{CP} that John loves Mary]] to be surprising]

The fact that clausal arguments are sensitive to the conditions on nominal licensing further supports their status as DPs.

Another argument comes from the licensing of ‘emphatic’ reflexives. Subject DPs such as *the professor* in (4a) can associate with an emphatic reflexive *herself* that matches in φ -features. Davies & Dubinsky (2001) illustrate that the same is also true for sentential subjects (4b). This parallel further supports the assumption of a DP-layer for such clauses.

(4) *Licensing of emphatic reflexives* (Davies & Dubinsky 2001:249f.):

- a. [_{DP} The professor] *herself* offered the student sage advice.
- b. [_{DP} [_{CP} That there were 25 miles to go]] was *itself* enough to discourage Edwin.

A final suggestive parallel comes from the status of sentential subjects as islands for extraction (Ross 1967). While extraction from (some) complement clauses is possible (5a), sentential subjects do not allow this (5b). It is interesting to note that the DP shell analysis in (5b) gives rise to the same structural configuration

as Complex NP islands (5c). If it is this DP+CP configuration that renders movement impossible, as in the traditional Subjacency account of Chomsky (1973, 1977), then this supports the assumption of a DP shell in (5b).

(5) *Sentential subjects as Subjacency islands* (Ross 1967:241):

- a. The teacher who₁ it was expected [_{CP} that the principle would fire ___₁]
- b. *The teacher who₁ [_{DP} [_{CP} that the principle would fire ___₁]] was expected
- c. *The teacher who₁ I heard [_{DP} a rumour [_{CP} that the principle would fire ___]]

A second strand of research has argued that certain types of sentential complement can be nominal (e.g. Kiparsky & Kiparsky 1970, Perlmutter & Soames 1979, Müller 1995, Müller & Sternefeld 1995, Adger & Quer 2001, Potts 2002, Hankamer & Mikkelsen 2012, Takahashi 2010, Hartman 2012, Kastner 2015, Pietraszko 2019). In particular, one factor that has been deemed relevant for the nominal status of a clausal object is whether the predicate that selects it is factive or not. On this view, the clausal complement to a factive verb such as *regret* in (6) is nominal, i.e. contains DP-shell structure.

(6) We all regret [_{DP} [_{CP} that John won the race]] (...#but he didn't)

Kiparsky & Kiparsky (1970) in particular argued that factivity was central to the nominal status of a given sentential complement. One piece of evidence they point to in support of this is that there is no raising-to-object (R-to-O) from the complement of factive verbs such as *regret* (7a), in contrast to non-factive predicates such as *believe* (7b). Kiparsky & Kiparsky (1970) attribute this to the status of factive complements as Complex NP Islands, as described for (6).

(7) *No R-to-O from factive complements* (Kiparsky & Kiparsky 1970:16of.):

- a. *He regrets [_{VP} Bacon₁ [_{DP} [_{CP} ___₁ to be the real author]]]
- b. He believes [_{VP} Bacon₁ [_{CP} ___₁ to be the real author]]

A further argument they present comes from the possible pro-forms that can correspond to clausal arguments. Non-factive complements can take either the DP pro-form *it*, or the CP pro-form *so* (8a). Complements to factive verbs such as *regret*, on the other hand, can only take the DP pro-form *it*, suggesting that they are strictly nominal in nature.

- (8) *Factive complements take DP pro-forms* (Kiparsky & Kiparsky 1970:166):
- a. John supposed [_{CP} that Bill had done it], and Mary supposed [_{DP} it] / [_{CP} so] too
 - b. John regretted [_{DP} that Bill had done it], and Mary regretted [_{DP} it] / * [_{CP} so] too

A similar diagnostic is provided by Kastner (2015), who pointed out the contrast in (9). In (9a), coordination of a nominal and clausal argument of the non-factive predicate *claim* fails, presumably due to a categorial mismatch (however, see Sag et al. 1985 and section 4.3 for discussion of some exceptions). With complements to factive verbs like *deny* (9b), however, Kastner (2015) notes that this mismatch does not seem to arise. Again, this follows if the sentential complement in (9) is actually a DP.¹

- (9) *Factive complements can be coordinated with DPs* (Kastner 2015:173):
- a. *John claimed [_{DP} responsibility] and [_{CP} that the building collapsed]
 - b. ?John denied [_{DP} the allegations] and [_{DP} that the building collapsed]

A slightly different argument for the status of some object CPs comes from the observation by Postal (1994) that the trace of moved complement clauses have the distribution of nominals. First, notice that a CP cannot typically occur as the complement of a preposition (10a). If the CP is extracted, however, the structure is well-formed (10b). This seems to suggest that, at least when they are to be moved, clausal complements can be nominal (see Hartman 2012).²

¹Ormazabal (2005:104) mentions a potential challenge for the view that (factive) CPs are nominal, namely that that clausal complements cannot combine with the expletive correlate *there* (ia). As shown by Postal & Pullum (1988:643), they must instead take *it* (ib).

- (i) a. *They never mentioned *there* to the candidate [_{CP} that the job was poorly paid]
- b. They never mentioned *it* to the candidate [_{CP} that the job was poorly paid]

If the *there* is an expletive associated with DPs, then this could be viewed as an argument against the status of these clauses as DPs. However, much depends on the correct analysis of such cases, which might involve extraposition from an underlying single constituent (see e.g. Pullum 1979:47f.).

²It is important to mention, however, that an alternative account of (9) has been proposed, whereby the fronted CP is a ‘satellite’ associated to a nominal null operator that moves from the complement position of the preposition (e.g. Emonds 1972, Koster 1978, Stowell 1981, Alrenga 2005, Moulton 2009, 2013). For discussion of an alternative, see section 4.3.

(10) *CP gaps have nominal distribution* (Postal 1994:70):

- a. *I couldn't convince Frank [PP of [CP that Sonia was very competent]]
- b. [DP [CP That Sonia was very competent]] I couldn't convince Frank [PP of —DP]

Thus, it seems that there a large body of research that shows that clausal arguments at the very least *can* be DPs. This has repercussions for the theory of selection, however. For example, now we must envisage (perhaps optional) c-selectional features for C and D respectively, depending on the type of clause that is selected (11).

(11) *Optional subcategorization for clause-embedding*:

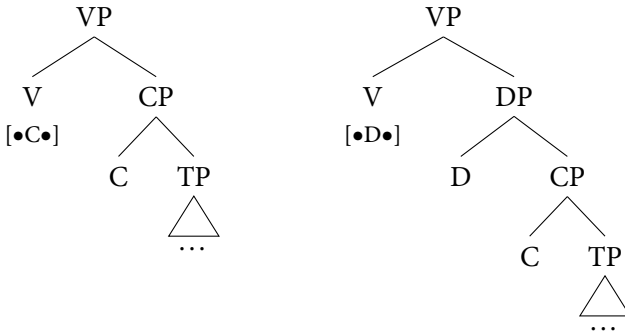

While this is one way to capture the seemingly necessarily optionality of clausal selection, another is to adopt what we might call the *Radical DP Shell Hypothesis* in (12).

(12) *The (Radical) DP-Shell Hypothesis* (cf. Müller 1995:53):

All finite clauses are DPs ([DP D [CP ...]]).

On this view, there is only c-selection by verbs for the category D. This means that all clausal arguments are born as DPs. Any genuine CP complements must then be derived in the syntax. Indeed, this is what Kiparsky & Kiparsky (1970) argued for non-factive complements, namely that the nominal shell was removed by means of a ‘*Fact-deletion*’ operation. However, in general, one might wonder whether it is possible to distinguish this ‘derivational’ view of the DP/CP distinction from the ‘inherent’ view in (11).

In this paper, we will present an argument in favour of the former view that

all clausal arguments originate with DP a shell and may lose this shell in the course of the derivation. The evidence for this comes from the distribution of the so-called *clausal determiner* in two Kwa languages spoken in Ghana, Gã and Akan. As the name suggests, clausal determiners are determiner-like elements that are found on clausal arguments. Thus, they seem to provide overt evidence for the kind of DP-shell on clauses that has otherwise been motivated based on more indirect evidence for languages like English, as we saw above. Examples of clausal determiners in the respective languages are given in (13). In Gã, the determiner *lɛ*, which is also found with nouns, is obligatory in the complement clause in (13a). Similarly, the determiner *nó* in Akan can optionally be realized on clauses, as in (13b).

- (13) a. Mɛni₁ ni Kwei yɔse [CP akɛ Yɛmo he —₁ *(lɛ)] ?
 what FOC Kwei realise that Yɛmo buy CD
 ‘What did Kwei realise that Yemo bought?’ (Gã)
- b. Dééni₁ na Kofi káé [CP sɛ Ám¹má kítá —₁ (nó)] ?
 what FOC Kofi remember that Ama hold CD
 ‘What does Kofi remember that Ama is holding?’ (Akan)

As we will see, the clausal determiners (CD) in Akan and Gã show a complex distribution that is difficult to capture neatly under the inherent view that clauses are sometimes DPs and sometimes CPs. Instead, we will show that a syntactic process of *Structure Removal* that eliminates the DP projection in a [DP [CP ...]] configuration will provide a general and explanatory account of the contexts in which the CD can occur and those in which it cannot.

In section 2, we elaborate on the nature and distribution of the CD in the two languages, arguing that it is a genuine D head selecting a CP. We show that the various contexts in which it arises cannot easily be captured as a natural class. Section 3 argues that a unified account can be provided by Structure Removal, that is, the contexts in which the CD can or must surface are those contexts in which Structure Removal fails to apply. Finally, section 4 extends the Structure Removal analysis to related puzzles about complementation in other languages, namely complementizer-drop in English, extraction from DPs in German and nominal properties of moved clauses.

2. Clausal determiners in Kwa

2.1. The CD in Kwa is not related to factivity

As mentioned earlier, a common idea is that the presence or absence of a DP-shell on clauses is related to factivity. If clausal determiners are the realization of such a nominal layer, we might expect them to also be sensitive to this property. Indeed, this is precisely what Kastner (2015) claims for Hebrew. A complement clause without a clausal determiner is not subject to a factivity restriction (14a), as shown by the bracket continuation. If this clause contains the clausal determiner *ze*, however, the CP must be interpreted as factive (14b).

(14) *Clausal determiner tracks factivity in Hebrew* (Kastner 2015:160):

- a. hu hisbir [CP še-ha-binyan karas] (aval hu lo
 he explained COMP-the-building collapsed but he NEG
 be'emet karas)
 really collapsed
 'He explained that the building collapsed (but it didn't).
- b. hu hisbir et [DP ze [CP še-ha-binyan karas]]
 he explained ACC this COMP-the-building collapsed
 (#aval hu lo be'emet karas)
 but he NEG really collapsed
 'He explained that the fact that building collapsed (#but it didn't).

However, it is not universally the case that clausal determiners mirror factivity. In Greek, clausal arguments take a clausal determiner *to* (15).

(15) *Clausal determiner in Greek* (Roussou 1991:78):

- [DP to [CP oti ehis filus]] simeni pola
 the.NOM that have.2SG friends means much
 'That you have friends means a lot.'

However, Moulton (2017) points out that the presence of a CD in Greek does not entail the truth of that clause, as demonstrated by the example in (16).

(16) *Greek sentential subjects do not have to be factive* (Moulton 2017:296):

- [DP to [CP oti ine plusios]] ine psema
 the.NOM that is.3SG rich is lie
 'That he is rich is a lie.'

The situation is similar in Akan and Gã. The Gã examples in (17) show that there is a distinction between factive and non-factive clause-embedding predicates, i.e. *jwɛŋ* ‘think’ (17a) vs. *yɔse* ‘realize’ (17b). However, when the clause is interpreted as factive (17b), the CD still cannot surface.

(17) *Factivity does not correlative with clausal determiner in Gã:*

- a. Kwei *jwɛŋ* [_{CP} *akɛ* *Yɛmo* *he* *yɛɛ* (**lɛ*)] ... *Shi* *asomoa*
 Kwei think that Yemo buy yam CD but apparently
e-je-ee anɔakwale
 3SG-be-NEG true
 ‘Kwei thought that Yemo bought yam ... but apparently it is not true.’
- b. Kwei *yɔse* [_{CP} *akɛ* *Yɛmo* *he* *yɛɛ* (**lɛ*)] ... #*Shi* *asomoa*
 Kwei realize that Yemo buy yam CD but apparently
e-je-ee anɔakwale
 3SG-be-NEG true
 ‘Kwei realized that Yemo bought yam ... #but apparently it is not true.’

Furthermore, in cases where the CD is obligatory, such as the sentential subject in (18), there is no factivity restriction, analogous to the Greek example in (16).

(18) *Sentential subjects in Gã do not have to be factive:*

- [_{CP} *Akɛ* *Kwei* *na* *Yɛmo* **(lɛ)*] *e-je-ee anɔakwale*
 that Kwei see Yemo CD 3SG-BE-NEG true
 ‘That Kwei saw Yemo is not true.’

From this, we conclude that the distribution of the CD in Akan and Gã cannot be reduced to factivity, unlike what has been claimed for some other languages.

2.2. The distribution of the clausal determiner

In this section, we turn to the distribution of the clausal determiner in Akan/Gã. As we will see, it has a rather complex distribution that involves a rather varied set of contexts.

2.2.1. *Extraction from complement clauses*

The first context for the clausal determiner in Akan/Gã is on complement clauses from which extraction has taken place. Starting with Gã, the embedded clause

without extraction in (19a) cannot have the CD *lɛ*. As soon as we extract from this clause though, the CD becomes obligatory (19b).

(19) *Extraction from verb complement clauses in Gã:*

- a. Kwei yɔse [CP akɛ Yɛmo he yɛlɛ (*lɛ)]
 Kwei realise that Yɛmo buy yam CD
 ‘Kwei realised that Yemo bought yam.’
- b. Mɛni₁ ni Kwei yɔse [CP akɛ Yɛmo he ____₁ *(lɛ)] ?
 what FOC Kwei realise that Yɛmo buy CD
 ‘What did Kwei realise that Yemo bought?’

The same can be seen in Akan. Embedded clauses without extraction cannot take the CD *nó* (20a), whereas those containing an extraction site must (20b).

(20) *Extraction verb complement clauses in Akan:*

- a. Kofi kaé [CP sɛ Ám¹ má kita bayéré (*nó)]
 Kofi remember that Ama hold yam CD
 ‘Kofi remembers that Ama is holding a yam.’
- b. Déé₁ na Kofi kaé [CP sɛ Ám¹ má kítá ____₁ (nó)] ?
 what FOC Kofi remember that Ama hold CD
 ‘What does Kofi remember that Ama is holding?’

This pattern also holds for clausal complements to nouns. In the Gã example in (21a), the CP is the complement of the noun *huhuuhu* and cannot have the clausal determiner. If we extract from this complement clause, however, then the CD becomes obligatory (21b).

(21) *Extraction from noun complement clauses in Gã:*

- a. Wɔ-nu [DP huhuuhu ko [CP akɛ gbɔ-i lɛ e-ba
 3PL-hear rumour INDEF that visitor-PL DEF 3SG-come
 (*lɛ)]]
 CD
 ‘We heard a rumor that the visitors have come.’
- b. [DP Gbɔ-i lɛ₁ [CP ní wɔ-nu [DP huhuuhu ko [CP akɛ
 visitor-PL DEF REL 3PL-hear rumour INDEF that
 amɛ₁-ba *(lɛ)]]]] nɛ
 3PL-come CD this
 ‘These are the visitors that we heard the rumor that they have arrived.’

This same pattern is shown for the analogous Akan example in (22).

(22) *Extraction from noun complement clauses in Akan* (Salzmann 2017:194):

- a. Me-te-e [DP atetésém bí [CP sé Kofi fe-e n'
1SG-hear-PST rumour INDEF that Kofi kiss-PST 3SG.POSS
anó (*nó)]
mouth CD
'I heard a rumour that Kofi kissed her (mouth).'
- b. [DP ɔbáá nó₁ [CP áa me-té-e [DP atetésém bí [CP sé
woman the REL 1SG-hear-PST rumour INDEF that
Kofi fé-e n'₁ anó]] *(nó)]
Kofi kiss-PST 3SG.POSS mouth CD
'The woman that I heard a rumour that Kofi kissed her.'

In sum, we see that complement clauses to both noun and verbs can only surface with the clausal determiner if they have been extracted from.³

2.2.2. Sentential subjects

Sentential subjects must obligatorily occur with the clausal determiner in both Gã (23a) and Akan (23b).

- (23) a. [CP Ake amlalo le tse too no *(le)] fee maŋ-bii
COMP government DEF tear tax top CD do country-people
le naakpɛɛ
DEF wonder
'That the government reduced taxes surprised the people.' (Gã)
- b. [CP Sé Kofi á-si dán *(nó)] má-a Á¹má ání gyé-eé
that Kofi PERF-build house CD give-PAST Ama eye collect
'That Kofi has built a house made Ama happy.'
(Akan; cf. Hein 2017:10)

³The CD is also found with monoclausal extraction. We put this aside for now, and return to it in section 3.3.1.

2.2.3. *Relative clauses*

The same is true for relative clauses modifying nouns. The Akan relative clause in (24a) obligatorily occurs with the clausal determiner *nó*. This can also be seen in Gã (24b).

- (24) a. [DP *Ɔbáá₁* (*nó*) [CP *áa* *ɔ₁-wáré-e* *Kofi* *(*nó*)]] *fi*
 woman DEF REL 3SG-marry-PST Kofi CD be.from
Aburí.

Aburi

‘The woman who married Kofi is from Aburi.’

(Akan; Saah 2010:92)

- b. [DP *Ataade₁* *le* [CP *ní* *o-he* *—₁* *(*le*)]] *ye* *biɛ*
 dress DEF REL 3SG-buy CD be here

‘The dress that you bought is here.’

(Gã; Kropp Dakubu 1992:8)

2.2.4. *Preposed conditional clauses (in Gã)*

Finally, Gã shows a positional asymmetry with regard to the clausal determiner on conditional clauses. If the conditional appears clause-finally, then the clausal determiner *le* is not possible (25a). If the conditional clause precedes the consequent, however, then the clausal determiner is obligatory (25b).

(25) *Conditional clauses in Gã* (Kropp Dakubu 1992:9):

- a. *M-á-yá* [CP *ké(jí)* *o-ba* (**le*)]
 1SG-FUT-go COND 2SG-come CD

‘I will go if you come.’

- b. [CP *Ké(jí)* *o-ba* *(*le*)] *m-á-yá*
 COND 2SG-come CD 1SG-FUT-go

‘If you come, I will go.’

2.2.5. *Interim summary*

We can therefore summarize the contexts for the CD as follows:

(26) *Contexts for clausal determiner in Kwa:*

Complement CPs	✗
Complement CPs with extraction	✓
Sentential subjects	✓
Relative clauses	✓
Initial conditional CPs (Gã)	✓
Final conditional CPs (Gã)	✗

As is clear from the preceding discussion, the CD occurs in a rather heterogeneous set of environments. Thus, the relevant question at this point is what is the feature that unifies these contexts as a natural class?

2.3. What is the clausal determiner?

Before we turn to the unifying property behind the distribution of the CD in Akan and Gã, let us first clarify the syntactic status of the clausal determiner. In the previous literature on the CD in Kwa, there have been two claims that we will dispute in what follows: (i) the clausal determiner is a functional category other than D (Lefebvre 1992*a,b*, Aboh 2004), (ii) the clausal determiner is a 'low' (ν P) adjunct (Renans 2016, Grubic & Renans 2017).

Instead, we will show that the clausal determiner in Akan and Gã is best analyzed as a D^0 head that selects a CP directly, as shown in (27) (also see Pietraszko 2019 on Ndbele).

(27) [DP [CP ...] [D^0 nó/lɛ]]

2.3.1. *The clausal determiner is a D^0 head*

For some languages, it has been claimed that clausal determiner encodes 'familiarity', for example in Haitian Creole and Fon(gbe) by Lefebvre (1992*a*) and also in Gungbe relative clauses (28) (Aboh 2005).

(28) *Clausal determiner encodes familiarity in Gungbe* (Aboh 2005:270f.):

- a. Kofí xò [DP agásá [CP dě mí wlé]]
 Kofi buy crab REL we catch
 'Kofi bought the crab that we caught.'

- b. Kofí xò [DP agásá [CP dĕ mí wlé] Ió]
 Kofi buy crab REL we catch DET
 ‘Kofi bought the aforementioned crab that we caught.’

For this reason, the CD has been analyzed a discourse/agreement-related functional head in some higher periphery of the clause, rather than an actual determiner (Agr⁰ by Lefebvre 1992*a* and Top⁰ by Aboh 2005).

We argue that this characterization of the CD is not correct for Akan and Gã, however, and that the CD is a genuine determiner, i.e. D⁰. This can be demonstrated using the haplology effect identified by Saah (1994). Saah proposes the rule in (29), which deletes a sequence of adjacent, homophonous D⁰ elements.

(29) *Pleonastic Determiner Deletion Rule* (Saah 1994:155):

$$[D \text{ no }] [D \text{ no }] \Rightarrow \emptyset [D \text{ no }]$$

In Akan, a sequence of the resumptive pronoun *nó* and CD *nó*, which have identical forms, is tolerated (30a). Since the resumptive pronoun is not a D⁰ element, the rule in (29) does not apply. However, if the CD is preceded by a genuine definite determiner belonging to an object DP, for example, then the context for the rule in (29) is met and one of them must be deleted (30b).

(30) *Haplology effect in Akan* (Saah 1994:151f.):

- a. [DP Abrofrá₁ [CP áa Kofí hú-u nó₁ *(nó)]] á-ba
 child REL Kofi saw-PAST 3SG CD PFV-come
 ‘The child that Kofi saw has come.’
- b. [DP Onípá₁ [CP áa ɔ₁-tó-o [DP ndwóm nó] *(nó)]]
 person REL 3SG-throw-PAST song DEF CD
 yɛ-ɛ adé
 do-PST something
 ‘The person who sang the song did well.’

Korsah (2017) shows that the same is true for Gã, where object resumptives do not lead to haplological dissimilation (31a), but object determiners do (31b).

(31) *Haplology effect in Gã* (Korsah 2017:157):

- a. Námɔ₁ ni Osa le [CP áké Taki tsé Ié₁ *(lé)] ?
 who FOC Osa know that Taki call 3SG CD

‘Who does Osa know that Taki called?’

- b. Taki ni Osa le [CP áké e₁-hé [DP tsóné lɛ] (*lɛ)]
 Taki FOC Osa know that 3SG-buy vehicle DEF CD
 ‘It is Taki that Osa knows bought the vehicle.’

Since the anti-haplology rule in (29) cares about the syntactic, as well as phonological properties of the adjacent items, it provides a useful diagnostic for the clausal determiner as a genuine determiner.⁴ We therefore conclude from this that the CD in both languages is the realization of the head of a DP shell dominating the clause.

However, this may not be true for all CDs cross-linguistically. Somewhat revealingly, the CD in Fon, which is argued by Lefebvre (1992a) not be a determiner, does not give rise to a haplological dissimilation:

(32) *No haplology with clausal determiners in Fon* (Lefebvre 1992a:138):

- Súnù ó gbá [DP mótó ó] ó
 man DET destroy car DET DET
 ‘The man destroyed the car, as we expected/knew.’

This is compatible with the claim that the final ó in (32) is indeed not a D⁰ element, but perhaps a functional head of some other category. The consequence is that ‘clausal determiners’ may not form a homogeneous class cross-linguistically, however we will not explore this issue further.

2.3.2. *The clausal determiner is high*

Now we have determined what kind of element the CD is in the relevant languages, the question remains where exactly it is located. Since it typically occurs clause-finally, it is difficult to diagnose precisely how high the CD attaches to the clause in question. There have been two major proposals in the literature to so far. Saah (1994) argued that the CD occupies a relatively high position, attaching to the clause directly (33). Others have argued, mainly on

⁴Furthermore, Korsah & Murphy (to appear) note that this provides an argument against treating resumptive pronouns in Kwa as the result of NP ellipsis (i) (e.g. Elbourne 2001), as was explicitly suggested for Akan by Arkoh & Matthewson (2013:27).

(i) [DP Abrofrá₁ [CP áa Kofi hú-u [DP abrofrá nó₁]] *(nó)] á-ba
 child REL Kofi saw-PAST child 3SG CD PFV-come

semantic grounds, that the CD is merged lower, namely adjoined to *vP* (34) (e.g. Renans 2016, Grubic & Renans 2017).

(33) *High analysis of the clausal determiner* (Saah 1994:162):

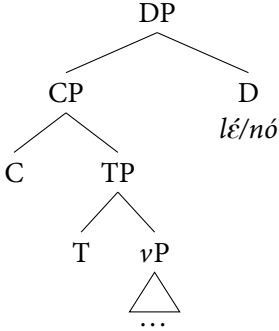

(34) *Low analysis of the clausal determiner* (Renans 2016:175):

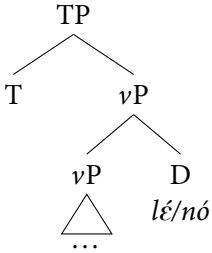

We will adopt the analysis in (33), assuming that D selects the CP.⁵ One reason for rejecting the ‘low’ analysis in (34) is that the clausal determiner does not

⁵It is interesting to note that this structure superficially seems to violate the *Final-over-Final Condition* (i), which prohibits a head-final phrase embedding a head-initial phrases within the same extended projection.

(i) *Final-over-Final Condition* (Biberauer et al. 2014:171; Sheehan et al. 2017):

A head-final phrase αP cannot dominate a head-initial phrase βP , where α and β are heads in the same extended projection.

*[βP [αP α γP] β]

This suggests that the clausal determiner does not belong to the extended projection of the verb (cf. Pietraszko 2019). Event nominalization in Akan appears to behave differently, when a head-final nominalizer attaches to a head-initial VP, the order of verb and object must be reversed to avoid a FOFC violating sequence ($[_{nP} [_{VP} V O]-n] \Rightarrow [_{nP} [_{VP} O V]-n]$), see Hein & Murphy (2018) for discussion.

behave like a low, vP-level adjunct with regard to pro-drop. First, consider the fact that inanimate pronouns are typically dropped in Gã (35b) (Korsah 2017).

(35) *No inanimate object pronouns in Gã:*

- a. Momo shá [DP mfoníri lé]
 Momo snap photo DEF
 ‘Momo took the photo.’
- b. Momo shá (*lé)
 Momo snap 3SG
 ‘Momo took it.’

However, this effect is obviated in the presence of a clause-final adverb (36).

(36) *Clause-final VP-adverbs trigger overt inanimate pronouns:*

- a. Momo shá *(lé) [Adv oyá]
 Momo snap 3SG quickly
 ‘Momo took it quickly.’
- b. Momo shá *(lé) [PP yε La]
 Momo snap 3SG at La
 ‘Momo took it in La.’

It is important to establish that this is not just an effect of clause-finality, since the sentence-final imperative marker *mmó* in Gã (cf. Kropp Dakubu 2008:96) does not block inanimate pro-drop (37b).

- (37) a. Momo, shá [DP mofoníri lé_i] mmó!
 Momo snap picture DEF IMP
 ‘Momo, take the photo!’
- b. Momo, shá (*lé_i) mmó!
 Momo snap 3SG IMP
 ‘Momo, take it!’

(ii) a. Kofi [vP á-si dán]
 Kofi PRF-build house
 ‘Kofi has built a house.’

- b. [vP dán sí]-é na Kofi á-yó
 house build -NMLZ FOC Kofi PRF-do
 ‘Kofi has BUILT A HOUSE. (not e.g. bought a boat)’

(Hein 2017:7)

The imperative marker *mmó* in (37b) does not block pro-drop since it presumably occupies a higher left-peripheral position such as the head of ForceP.⁶ Thus, it is only a certain kind of clause-final element that blocks the regular process of inanimate pro-drop, namely low, *v*P-level adverbs. This gives rise to the descriptive generalization in (38), which we will utilize as a diagnostic for attachment of rightward elements (see Korsah 2017 for a suggestion on how it can be derived).

- (38) *pro-drop generalization* (Saah 1994, Osam 1996, Korsah 2017):
 Low, *v*P adverbs block deletion of inanimate pronouns.

Importantly, the clausal determiner behaves like the imperative marker in not blocking object drop, as shown by (39).

- (39) Tsoné lé₁ ni Osa le [CP áké Taki hé (*lé₁) lé]
 vehicle DEF FOC Osa know that Taki buy 3SG CD
 ‘It is the car that Osa knows that Taki bought.’

This follows if the CD occupies a high position, just like imperative *mmó*:

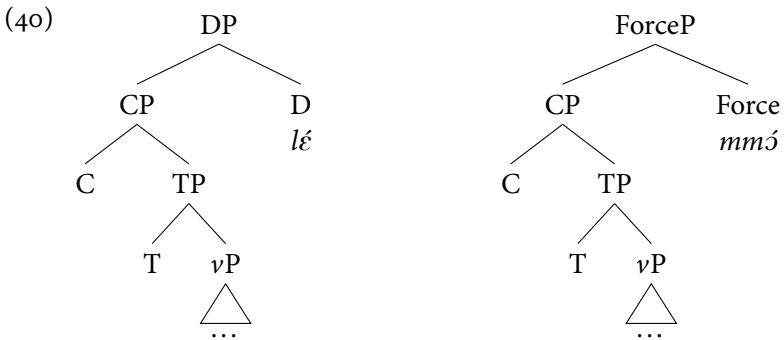

⁶The assumption that *mmó* is indeed higher than VP-adverbs is confirmed by the fact that it must follow adverbs (ia).

- (i) a. Momo, shá lé_i oyá mmó!
 Momo snap 3SG quickly IMP
 ‘Momo, take it quickly!’
 b. *Momo, shá lé_i mmó oyá!
 Momo snap 3SG IMP quickly
 ‘Momo, take it quickly!’

An analogous argument can be made for Akan. As (41b) shows, inanimate pronouns are also ordinarily dropped in object position.

- (41) a. Kofi di [_{DP} aduane nó] b. Kofi di (*nó)
 Kofi eat food DEF Kofi eat 3SG
 ‘Kofi eats the food.’ ‘Kofi eats it.’

As in Gã, this process is blocked by clause-final adverbs in Akan (42a). Importantly, high clause-final functional heads such as the question particle *anaa* do not obviate inanimate pro-drop (42b).

- (42) a. Kofi di *(nó) anɔpá b. Kofi di (*nó) anaa ?
 Kofi eat 3SG morning Kofi eat 3SG Q
 ‘Kofi eats it in the morning.’ ‘Does Kofi eat it?’

Recall from example (13b), repeated below as (43), that the clausal determiner in Akan patterns with the question particle rather than low, *v*P adverbs in that it does not block pro-drop of the resumptive pronoun in (43) (note that resumptive pronouns and anaphoric pronouns have the same distributional properties; see Korsah & Murphy to appear).

- (43) Déén_i na Kofi káé [_{CP} sɛ Ám¹má kítá (*nó) (nó)] ?
 what FOC Kofi remember that Ama hold 3SG CD
 ‘What does Kofi remember that Ama is holding?’ (Akan)

From this, we conclude that the CD in both Akan and Gã is a D⁰ that attaches at the CP-level.

3. Analysis

Let us now see how we can unify the contexts in which we find the clausal determiner in Akan and Gã. We will show that the distribution of the CD in Kwa can be captured by assuming that the DP shell is present underlyingly, but ordinarily deleted in the complement position of verbs (and nouns). This is shown schematically in (44).

(44) *Removal of DP shell:*

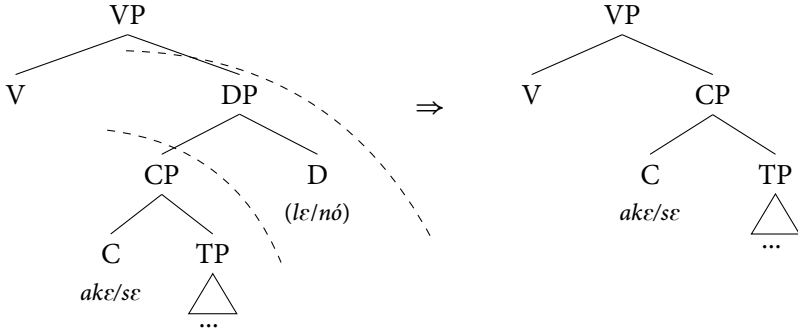

On this view, the contexts in which the CD surfaces are the contexts in which Removal of DP fails, for principled reasons. Thus, we have to appeal to what might be the opposite of our first intuition. Rather than asking when a DP shell can be added to a CP, we have to ask when it cannot be removed. To this end, we will define the process of Structure Removal in more detail.

3.1. Structure Removal (Müller 2017, *et seq*)

In order to implement the Remove analysis, we will adopt the feature-driven approach to syntactic deletion has been recently proposed by Müller (2017, 2018, to appear, this volume^a, this volume^b) (also see Murphy 2016, Zyman 2018). As summarized in (45), this approach expands the ontology of formal features to include features of the type [-X-], which trigger removal of projections of category X.⁷

(45) *Structure Removal* (Müller 2017, 2018):

As well as structure-building features [•X•] that trigger Merge of a category X, there are structure-destroying features [-X-] that trigger Removal of an existing projection X in the structure.

To take an abstract example, if a head Y selecting a phrase XP bears a Remove feature [-X-], then this feature is checked by deleting the XP projection (46). Consequently, ZP becomes the new complement of Y.

⁷Müller (2017) suggests further diacritics on this feature to distinguish whether heads or entire phrases are removed, but for present purposes we will only deal with one type of Structure Removal, namely where a head and its associated projection are removed.

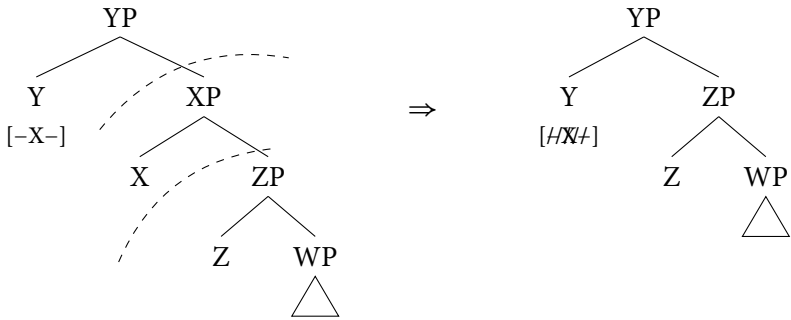
(46) *Feature-driven Structure Removal:*

For present purposes, Y corresponds to a clause-embedding predicate and XP to a DP shell on the embedded clause.

Müller (to appear) also employs this idea in his analysis of restructuring. He argues that restructuring in German shows conflicting evidence for both bi-clausality (CP boundary) and monoclausality (lack of CP boundary). This can be reconciled by having restructuring predicates merge with a finite CP (47a), and then later removing the CP projection (47b) (also see Pesetsky 2019 on *Exfoliation*).

(47) *Restructuring by Remove:*

- a. $[_{VP} V_{[-C-], [-T-]} [_{CP} C [_{TP} T [_{vP} v [_{VP} V DP]]]]]$ (*bi-clausality*)
- b. $[_{VP} V_{[H\cancel{C}H], [-T-]} [_{TP} T [_{vP} v [_{VP} V DP]]]]$
- c. $[_{VP} V_{[H\cancel{C}H], [HTH]} [_{vP} v [_{VP} V DP]]]$ (*mono-clausality*)

In (47c), the TP projection of the embedded clause has also been removed. This means that Remove can apply cyclically. However, in order to respect the Strict Cycle Condition, higher projections must be removed before lower ones (see section 4.1 for further discussion).

3.2. A restriction on Remove

The restrictiveness of the following analysis will rest, in part, on the assumption that all CPs are actually born as DPs and that this DP shell can be removed by a head bearing an $[-D-]$ feature. In addition, we make the following important two-part assumption about the Removal of DP shells in Kwa

(48) *Condition on Removal of DP:*

Removal of a DP shell can ...

- a. only take place in complement (but not specifier) position, and
- b. may not remove material other than D(P).

The first assumption restricts the application of Removal of DP shells in the languages in question to complements and not specifiers. While others have assumed Remove is possible in specifier position (e.g. Müller 2018, Schwarzer this volume), this could be a point of variation among languages. In the particular case of clausal determiners, this assumption receives some cross-linguistic support from the observation that, if a language has a subject/object asymmetry with regard to when a clause shows the CD, the table in (49) shows that it is always obligatory in subject position, and either optional or absent in object position.

(49) *Clausal determiners cross-linguistically:*

	Clausal Determiner?		
	Subject position	Object position	
Persian	+	–	(Hartman 2012)
Greek	+	–	(Roussou 1991)
Russian	+	–	(Hartman 2012, Knyazev 2016)
Polish	+	–	(Pietraszko 2019)
Uyghur	+	±	(Hartman 2012)
Hebrew	+	±	(Kastner 2015)
Spanish	+	±	(Picallo 2002)
Akan/Gã	+	±	(Korsah 2017)
Ndbele	+	+	(Pietraszko 2019)

This makes sense in light of (48a), since subject CPs do not occupy the complement position of a head that could remove their DP shell.⁸

The second part of (48) asserts that Remove is blocked in contexts where more than just the DP projection would be removed. In other words, if there

⁸The opposite is proposed by Hartman (2012) who suggests that DP shells can be Late Merged with clauses in order for them to be able to move to subject position (see Pietraszko 2019 for discussion).

is an element in Spec-DP, Remove will not apply.⁹ This will be important in explaining why the CD surfaces in extraction contexts.

With this in mind, we can move onto the various contexts for the clausal determiner. Recall the various contexts for the CD that we saw in (26), repeated below.

(50) Contexts for clausal determiner in Kwa:

Complement CP	✗
Complement CP with extraction	✓
Sentential subject	✓
Relative clause	✓
Initial conditional CP (Gã)	✓
Final conditional CP (Gã)	✗

The contexts in which the CD surfaces are the *exceptions* rather than the rule, i.e. the contexts in which Remove cannot apply.

3.3. Derivations

3.3.1. Extraction from complement CPs

The first context to consider is extraction from complement CPs, as in the Gã example in (51).

- (51) a. Kwei yɔse [CP akɛ Yɛmo he yɛɛ (*lɛ)]
 Kwei realise that Yɛmo buy yam CD
 ‘Kwei realised that Yemo bought yam.’
- b. Mɛni_i ni Kwei yɔse [CP akɛ Yɛmo he ___₁ *(lɛ)] ?
 what FOC Kwei realise that Yɛmo buy CD
 ‘What did Kwei realise that Yemo bought?’ (Gã)

⁹ Note that this differs crucially from what is assumed in other Remove analyses (Müller 2018, Schwarzer this volume). Here, the projection in question can still be removed and the stranded former specifiers reattach as specifiers of the next higher head. It may well be that there is cross-linguistic variation with regard to how languages deal with specifiers of removed phrases. A language like German may have access to this kind of ‘reattachment’ repair, whereas other languages, such as Akan and Gã, simply delete the feature without checking it.

In clauses without extraction, the DP shell will be removed by the embedding verb (52), leading to the impossibility of the clausal determiner in (51a).

(52) *Removal of DP shell:*

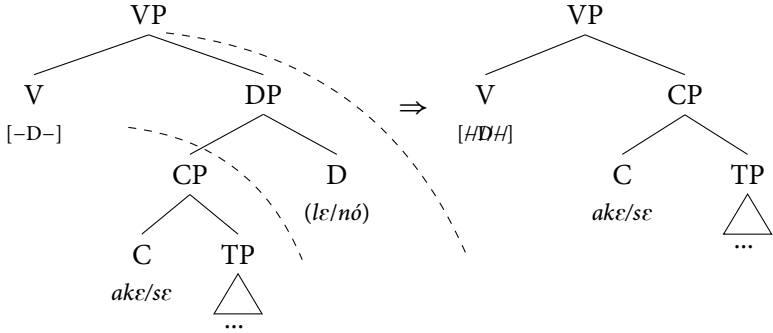

However, if the DP shell hosts material moving successive-cyclically to the edge of DP phase, given the condition in (48b), Remove cannot apply (53).¹⁰

(53) *Removal of DP shell blocked:*

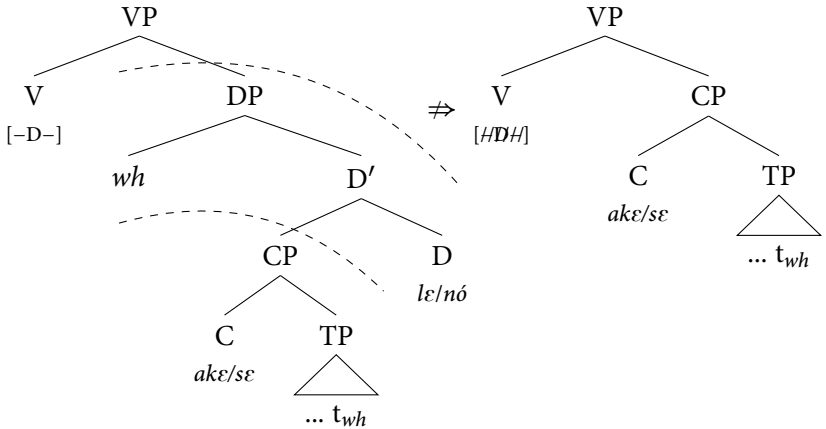

It is important to mention here that, although we have extraction from a Complex NP Island configuration, this need not be viewed as problematic, since these languages are not island-sensitive (see e.g. Saah 1994, Saah & Goodluck

¹⁰Note that would also be an intermediate landing site in Spec-CP if C is a phase. For expository purposes, we will not include this landing site in the trees.

1995 for Akan). Korsah & Murphy (to appear) argue that this follows from the syntax of resumption.

A further important point is that the clausal determiner is also found with monoclausal extraction.¹¹

- (54) a. Taki_i ni [TP t_i tsé Momo] (*lé*) ?
 Taki FOC call Momo CD
 ‘It is Taki who called Momo.’
 b. Hwáńi na Kofí tán nó_i (*nó*) ?
 who FOC Kofi hate 3SG.OBJ CD
 ‘Who does Kofi hate?’

This can be accounted for in the same matrix clauses are also DPs that are complements to some left-peripheral head, i.e. Fin (Rizzi 1997). In ordinary declarative clauses, Fin would bear a remove feature [-D-] that removes the DP shell on the matrix CP. Assuming that focused phrases land in a FocP projection above Fin, then successive-cyclic movement would have to stop at the edge of the DP on its way to Spec-FocP. As with embedded clauses, this would block removal of the DP shell (55).

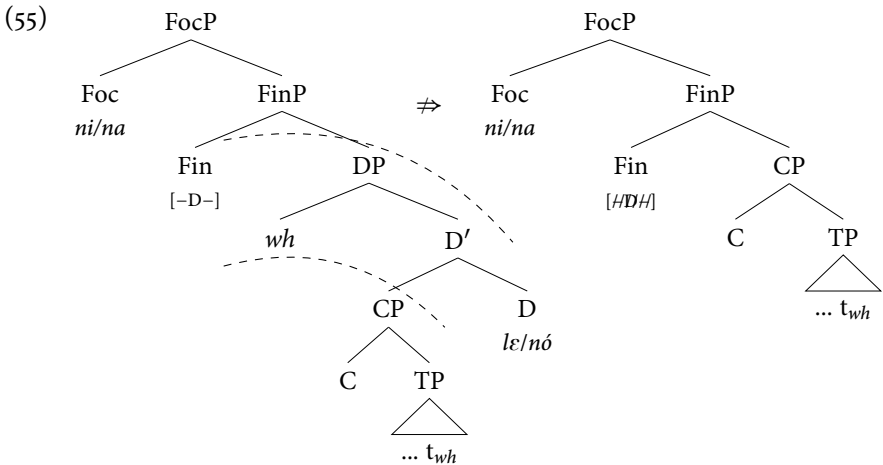

¹¹ Renans (2016) and Grubic & Renans (2017) assume that the clausal determiner in monoclausal contexts is a D head that adjoins to the *v*P. In section 2.3.2, we saw some reasons to doubt this. Furthermore, their account does not attempt to explain why the CD can only adjoin to *v*P from which extraction has taken place.

3.3.2. *Sentential subjects*

Recall that sentential subjects must always have a clausal determiner:

- (56) [CP Akɛ amlalo ɛ tse too nɔ *(ɛ)] fee maŋ-bii ɛ
 that government DEF tear tax top CD do country-people DEF
 naakpɛɛ
 wonder
 ‘That the government reduced taxes surprised the people.’ (Gã)

- (57) [CP Sé Kofi á-si dán *(nó)] má-a Á¹má ání gyé-eé
 that Kofi PERF-build house CD give-PAST Ama eye collect
 ‘That Kofi has built a house made Ama happy.’

This follows from the assumption in (48a) that Remove is restricted to complement position. Thus, even if a remove feature were present on V or *v* (58), it could not be checked by removing the DP shell of its specifier.

- (58) *No Removal of D in specifier position:*

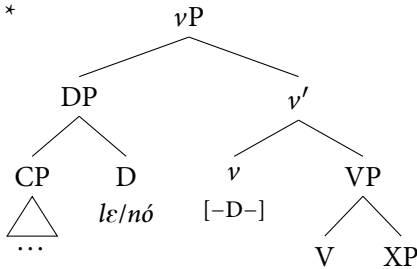

Consequently, derivations containing configurations such as (58) will crash. A convergent derivation with a sentential subject cannot contain a Remove feature on the head that introduces it.

3.3.3. *Relative clauses*

The third context for the clausal determiner involves relative clauses, where clausal determiners are obligatory on relative clauses in both Akan (59) and Gã.

(59) [DP ɔbáá₁ (nó) [DP [CP áa ɔ₁-wáré-e Kofi *(nó)]]] fi
 woman DEF REL 3SG-marry-PST Kofi CD be.from

Aburí.

Aburi

‘The woman who married Kofi is from Aburi.’

(Akan)

To account for this, we can adopt the traditional view that relative clauses are adjuncts to NP (e.g. Partee 1975). On this analysis, shown in (60), the relative is not in the complement position of the noun, for example, and therefore cannot be affected by remove feature.

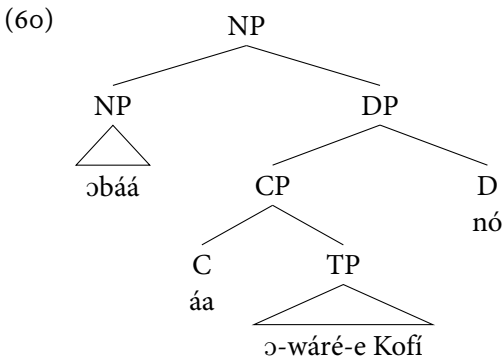

3.3.4. Conditional clauses

The final context we saw was conditional clauses in Gã. Final conditionals do not show the CD (61a), whereas conditional clauses in initial position must occur with the CD (61b).

(61) *Conditional clauses in Gã* (Kropp Dakubu 1992:9):

a. M-á-yá [CP ké(jí) o-ba (*lɛ)]
 1SG-FUT-go COND 2SG-come CD
 ‘I will go if you come.’

b. [CP Ké(jí) o-ba *(lɛ)] m-á-yá
 COND 2SG-come CD 1SG-FUT-go
 ‘If you come, I will go.’

As with the preceding cases, we argue that this also conforms to a complement/non-complement asymmetry. That is, the CP in (61b) is

immune from Remove of the D shell since it is not in complement position. In particular, we propose that conditionals have a similar syntax to coordination, intuitively supported by their close affinity (62) (Culicover & Jackendoff 1997, Weisser 2015a,b).

- (62) You drink another can of beer and I'm leaving (= If you drink another can of beer, I'm leaving).
 (Culicover & Jackendoff 1997:197)

Thus, we propose that conditionals are hosted in a functional projection analogous to the &P that is frequently assumed for coordination (e.g. Zoerner 1995). We call this projection Cond(itional)P (63).

- (63) *Functional projection for conditional clauses:*

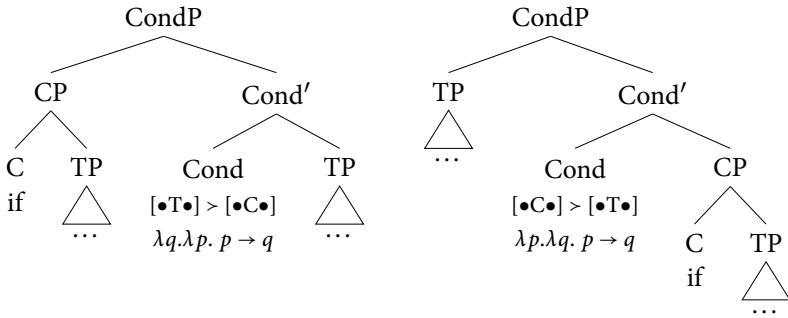

In this structure, a Remove feature [-D-] can be placed on the Cond head. Consequently, Cond can remove the DP shell on a conditional CP in its complement, i.e. utterance-finally (64).

- (64) *Removal of D in complement position:*

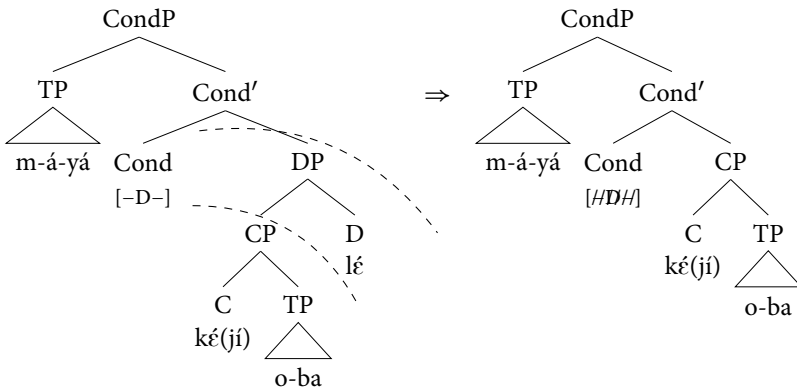

Given this structure, initial conditional clauses are not in complement position (cf. Adger & Quer 2001:125). Given the restriction in (48a), even if Cond bears the relevant Remove feature, it cannot remove the DP shell on the conditional clause.

(65) *No Removal of D in specifier position:*

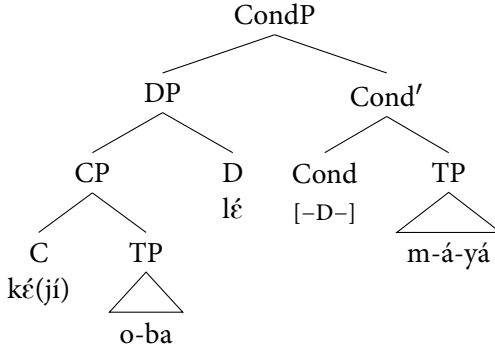

This accounts for the positional asymmetry with regard to clausal determiners on conditional clauses. This unifies them with both sentential subjects and potentially relative clauses as non-complement configurations.

3.3.5. *Interim summary*

In this section, we have seen that the seemingly heterogeneous contexts in which the CD occurs in Akan and Gã can be unified as the contexts in which Structure Removal of a DP shell on a CP fails. This is summarized in (66).

(66)	<i>Context</i>	<i>Remove blocked?</i>	<i>Reason</i>
	Complement CP	✗	
	Complement CP with extraction	✓	Moving item in Spec-DP
	Sentential subject	✓	Specifier position
	Relative clause	✓	Adjoined position / Head-raising
	Initial conditional CP (Gã)	✓	Specifier position
	Final conditional CP (Gã)	✗	

Other approaches that try to identify a natural class of contexts in which the clausal determiner can be added to a clause inevitably struggle to capture the distribution of the CD, since there is no clear semantic or morphosyntactic

property that unifies. The Structure Removal approach advocated here instead characterizes the contexts for the CD as those in which Removal of the DP shell fails.

3.4. Evidence from coordination

The analysis outlined in the preceding section assumed that all clauses are born with a DP shell that may or may not be removed in the course of the derivation. This means that even object CPs that cannot normally show the clausal determiner overtly should were DPs at some point in the derivation.

Some striking evidence for this comes from coordination. In both Akan and Gã, the form of the coordinator in conjunctions is sensitive to the category of the conjuncts. In Akan, for example, nominals can be coordinated either with *ne* or *na* (67a) (also see Larson 2013). Coordination of main clauses, however, cannot have the *ne* coordinator (67b) (see Renans 2016:98; Korsah 2017:14 for a similar pattern in Gã).

(67) *Category-sensitive coordination in Akan* (Kobebe & Torrence 2004):

- a. Me-hu-u [DP Kofi] **na/ne** [DP Ama]
 1SG-see-PST Kofi and Ama
 ‘I saw Kofi and Ama.’
- b. [TP Me-hu-u Kofi] **na/*ne** [TP wo-bɔ-ɔ Yaa]
 1SG-see-PST Kofi and 2SG-hit-PST Yaa
 ‘I saw Kofi and you hit Yaa.’

Importantly, when embedded TPs are coordinated, the *ne* coordinator found with nominals is not possible (68a). We can be sure that TPs are coordinated here since there is only a single complementizer. If the complementizer is repeated in the second conjunct, signaling that larger constituents are coordinated, then the nominal coordinator *ne* becomes possible (68b) (see Pietraszko 2019 for the similar data from Ndebele). We also find a similar pattern in Gã.

(68) *Clausal coordination in Akan allows nominal coordinator ne*:

- a. Kofi nim [CP sɛ [TP Ama kita bayerɛ] **na/*ne** [TP Yaw
 Kofi know that Ama hold yam and Yaw
 re-noa ɛmo]]
 PROG-cook rice
 ‘Kofi knows that Ama is holding yam and that Yaw is cooking rice.’

- b. Kofi nim [CP sɛ Amma kita bayerɛ] **na/ne** [CP sɛ Yaw
 Kofi know that Ama hold yam and that Yaw
 re-noa ɛmo]
 PROG-cook rice
 ‘Kofi knows that Ama is holding yam and that Yaw is cooking rice.’

This is striking since the form of the coordinator seems to indicate that coordinated embedded clauses have nominal properties, even though the clausal determiner cannot occur in an example like (68b).

We can analyze this as follows. Let us assume that there are two types of coordinators in Akan. The first is the general coordinator in (69a) that selects phrases of any category ($\bullet X \bullet$) and is realized as *na*. In addition to this coordinator, there is a more specific variant of & that only selects phrases of category D. Thus, in cases of coordination of object DPs (67a), either of the variants in (69) will be possible, whereas coordination of non-nominals will only be compatible with the coordinator in (69a).

(69) *Two lexical entries for & in Akan:*

- a. $\&_1$ = PHON: /na/, SEL: [$\bullet X \bullet$]
 b. $\&_2$ = PHON: /ne/, SEL: [$\bullet D \bullet$]

Thus, it is *prima facie* a puzzle why the coordinated clauses in (68b) can occur with the nominal coordinator even though the CD cannot surface overtly. However, on the present view that they are born with a DP shell that is later removed, this is in fact what we expect. At the point at which the clauses are conjoined, they are still DPs. Consequently, they can check the c-selectional requirements of the coordinator in (69b) that will be realized as *ne* (70).

(70) Step ①: Merge clausal DPs with CD

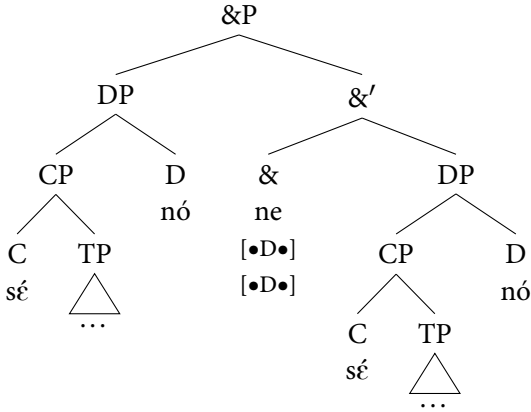

When the clause-embedding predicate is merged, its remove feature [-D-] will remove the shell of its complement. Note that the &P must be invisible for the purposes of selection and we assume that the same holds for checking Remove features. In (71), Remove applies to the DP shell in each conjunct (i.e. ATB-Removal). The absence of the DP shell on either clause accounts for the why the CD cannot occur in these contexts.

(71) Step ②: Remove DP shells

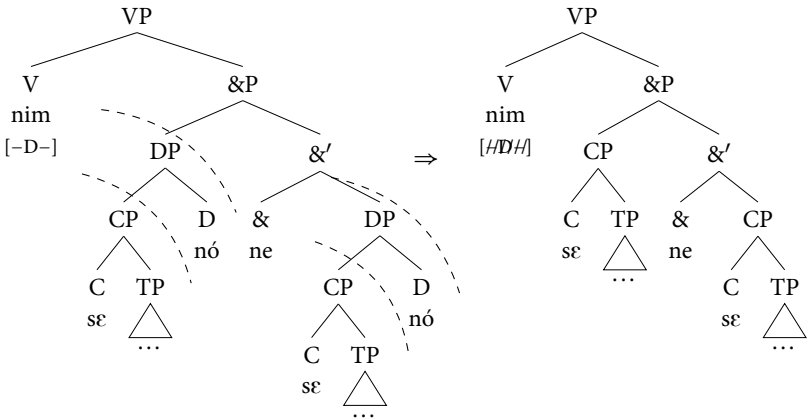

At this point, we have an *opaque* output. In other words, it looks like the coordinator *ne*, which is inherently specified to select only conjuncts of category D, has selected CPs. However, at an earlier point in the derivation, the

conjuncts were DPs. We can therefore view this as a kind of derivational opacity (counterbleeding). Selection applies early, while the clauses are still DPs, and only later are they stripped of this DP shell via Structure Removal. Had the operations been able to apply in the reverse order (Removal > Selection), then the resulting derivation would inevitably crash due to the inability to check the c-selectional features on &. To put it another way, Remove counterbleeds Selection in this analysis (see Benz this volume on another opaque interaction with Remove).

3.5. An allomorphy alternative?

Given that the previous section has provided evidence from coordination for the fact that DP shells are present (at least initially) even when they cannot ultimately be realized, let us briefly consider an alternative approach.¹² Instead of assuming that something like syntactic Structure Removal is responsible for the (non-)realization of a clausal determiner, we could treat this as an instance of movement-conditioned allomorphy of a DP projection that is always syntactically-present.

It is a well-established cross-linguistic fact that many languages show dedicated morphemes to signal the presence of a movement dependency in a given domain (see e.g. McCloskey 2002, Georgi 2014, van Urk 2015). Some of the contexts for the CD could potentially be accommodated under this view. In particular, those involving movement such as extraction from CPs and also relative clauses. Since the moved operator passes through Spec-DP, it would be conceivable that the CD is a form of the universally-present DP shell that is realized under a kind of Spec-Head agreement with a trace or copy (cf. Georgi 2014).

However, some other contexts would remain accounted for under this view. For example, in sentential subjects, it is not clear what allomorphy would be tracking. While some analyses of sentential subjects may posit null operator movement within the CP, there is clear evidence that is not the correct analysis for Akan. For example, Korsah & Murphy (to appear) show that \bar{A} -dependencies in the language are signaled by a reflex of high-tone overwriting on the verb. This also holds for some null operator dependencies inside adverbial clauses. Importantly, sentential subjects do not show this reflex, indicating the absence

¹²This approach has been suggested to us by, among others, David Adger (p.c.).

of a null operator dependency (72a). When an element is extracted from a sentential subject, the high tone reflex on the verb surfaces (72b).

- (72) a. [CP Sɛ́ Kofi dɔ́ Ámá nó] yɛ asem pá
 that Kofi love Ama CD be matter good
 ‘That Kofi loves Ama is good news.’
- b. Hwáń₁ na [CP sé Kofi dɔ́ nó₁ nó] ε-yɛ asem pá?
 who FOC that Kofi love 3SG.OBJ CD 3SG-be matter good
 ‘Who is that Ama loves her good news?’

Furthermore, it is unclear how the external distribution of conditional clauses in Gã could be related to the presence of a null operator dependency inside the conditional. For this reason, it seems that this alternative approach cannot adequately capture the full distribution of the CD in the languages in question, unlike the Structure Removal account advocated here.

4. Cross-linguistic perspective

4.1. Restrictions on complement clauses in English

The previous account based on the idea that clausal arguments are born as DPs that may or may not undergo Removal of this DP shell can also be extended to contexts beyond the clausal determiner in Kwa. In particular, it can account for two puzzling, and on the surface seemingly unrelated, puzzles regarding English complement clauses. First, as we saw in section 1, there is evidence that factive complement clauses contain nominal structure (e.g. Rosenbaum 1967, Ross 1967, Kiparsky & Kiparsky 1970, Müller 1995, Kastner 2015). One prominent argument for this is that the nominal structure makes them islands for extraction, i.e. complex NP islands (73).

(73) *Factive clauses do not allow extraction* (Adams 1985):

- a. *Who₁ does John hate [DP [CP that Mary loves ___₁]] ?
- b. *What₁ does society care [DP [CP that global warming is ___₁]] ?
- c. *How₁ do you regret [DP [CP that Arsenal lost the cup final ___₁]] ?

Furthermore, it has been noted that factive clauses differ from non-factives

in resisting complementizer drop (74) (Pesetsky 1991, Ormazabal 1995, 2005, Sheehan & Hinzen 2011).

(74) *No complementizer drop with factives* (cf. Bošković & Lasnik 2003):

- a. Flat earthers hate *(that) the world is round (#...but it isn't round)
- b. Society cares *(that) global warming is a problem (#...but it isn't a problem)
- c. The players regret *(that) they lost the cup final badly (#...but they didn't lose)

A similar set of restrictions hold for non-bridge verbs, e.g. manner-of-speaking verbs such as *quip*, *simper*, *lisp* (Ross 1967, Erteschik-Shir 1973). Complements to manner-of-speaking verbs are similar to factive complements in generally disallowing extraction (75).

(75) *Non-bridge verbs do not permit extraction* (Ross 1986:154):

- a. *Which₁ hat₁ did Mike quip [_{CP} that she never wore ___₁] ?
- b. *What₁ did she simper [_{CP} that home economics was ___₁] ?
- c. *Who₁ did John lisp [_{CP} that he hated ___₁] ?

Furthermore, there is an observation going back to Ross (1967) that these non-bridge verbs also disallow complementizer drop (76), just like the factive verbs in (74).

(76) *No complementizer drop with non-bridge verbs* (Ross 1967:252):

- a. Mike quipped [_{CP} that she never wore this hat]
- b. *Mike quipped [_{CP} Ø she never wore this hat]
- c. She simpered [_{CP} that home economics was a bore]
- d. *She simpered [_{CP} Ø home economics was a bore]

These two types of verbs therefore show the same pattern: inability to extract from a clausal complement correlates with inability to drop the complementizer of that clause. It is particularly puzzling why the non-overt realization of a C head as a complementizer, as is often assumed for complementizer drop, should be related to the availability of extraction from that complement.¹³

¹³ Of course, *that*-trace effects may come to mind here, but factive and manner-of-speaking complements also generally disallow extraction from object position (as shown above). Thus, they cannot simply be unified under some explanation of complementizer-trace effects.

These two seemingly unrelated properties can be given a unified analysis under a Structure Removal approach. As mentioned earlier, we can assume that, in English, extraction is blocked from clausal complements with a DP layer:

(77) *What₁ did she simpler [DP [CP that home economics was ₁]] ?

Furthermore, bridge predicates bear the feature [-D-], which removes the DP shell and permits extraction (Kiparsky & Kiparsky 1970). Factive and manner-of-speaking verbs are non-bridge predicates, meaning that they cannot, as a lexical property, bear a [-D-] feature. Since the DP layer cannot be removed, extraction is impossible (77).

Furthermore, let us assume that complementizer drop is derived by Removal of the CP layer via an optional [-C-] on the embedding verb. In the approach to restructuring proposed by Müller (to appear), Removal of the outer layer of the complement of a head bearing a Remove feature can take place recursively. In order to derive complementizer drop, we require two Remove features on the embedding verb. As illustrated in (78) the first removes the DP shell on the CP. Subsequently, the CP layer can be removed, resulting in complementizer drop.

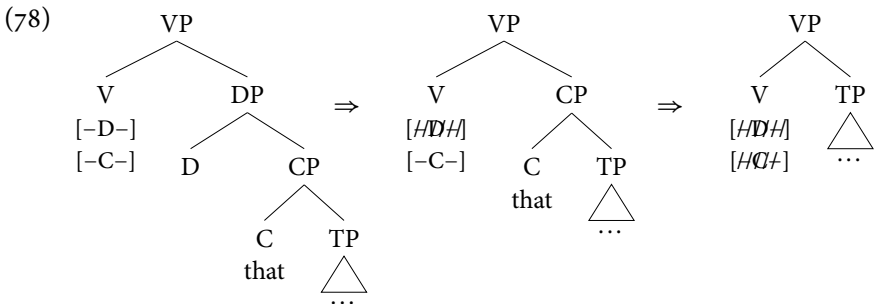

An important assumption here is that Remove obeys the Strict Cycle Condition, as defined in (79) (Müller 2017, to appear).

(79) *Strict Cycle Condition* (Chomsky 1973, McCawley 1984):
 No rule can apply to a domain dominated by a cyclic node A in such a way as to affect solely a proper subdomain of A dominated by a node B which is also cyclic node.

The result of this is that, assuming each XP is a cyclic node, a CP cannot be removed across an intervening DP shell due the Strict Cycle (80).

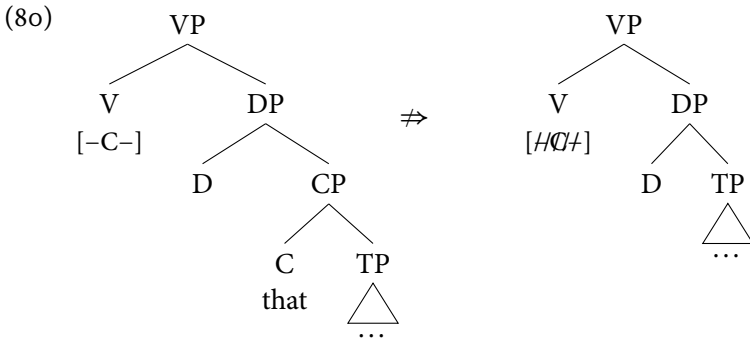

Recall above that we assumed that what factive and manner-of-speaking predicates have in common is that they cannot bear an $[-D-]$ feature. Thus, even if they happen to have the optional $[-C-]$ feature responsible for complementizer drop, this feature cannot be checked in the presence of a DP shell (80).

4.2. Lexical restrictions on sub-extraction from nominals in German

Given what we have seen so far, we might also expect to find $[-D-]$ on non-clausal embedding predicates, removing DP shells on objects. We argue that this could be what we find in the German examples in (81). Sub-extraction of a PP from a DP object is possible if it is the complement of *schreiben* ('write') (81a), but not as the complement of a different predicate such as *klauen* ('steal') (81b) (similar facts obtain in English; see Bach & Horn 1976).

(81) *Predicate determines subextraction* (Müller & Sternefeld 1995:41):

- a. [_{PP} Über wen] hat der Fritz [_{DP} ein Buch ____{PP}] **geschrieben** ?
 about whom has the Fritz a book written
 'Who did Fritz write a book about?'
- b. * [_{PP} Über wen] hat der Fritz [_{DP} ein Buch ____{PP}] **geklaut** ?
 about whom has the Fritz a book stolen
 'Who did Fritz steal a book about?'

Previous accounts of this variability involve positing a reanalysis operation based on subcategorization frames (Bach & Horn 1976, Chomsky 1977) or

assuming abstract incorporation that removes the ‘barrierhood’ of the DP (Müller & Sternefeld 1995, Müller 1995). It can also be accounted for under the Remove analysis outlined above.

First, let us adopt the theory of Bošković (2005) where inability to extract from a noun phrase is due to the presence of a DP phase. In particular, Bošković (2005) argues that the impossibility of PP extraction results from a combination of the phasehood of D and an Anti-Locality constraint stating that movement must cross a maximal projection other than the one in which it is immediately contained (Abels 2003, Grohmann 2003).

Given the *Phase Impenetrability Condition* (Chomsky 2000, 2001), a PP cannot be directly extracted from its base-position inside the DP (82a). Instead, it must move to the edge of the DP first, however this movement violates Anti-Locality since it only crosses the maximal projection which dominated it (NP) (82b).

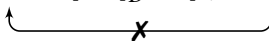
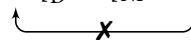
- (82) a. [PP ... [DP [D' D [NP N t_{PP}]]]] (violates PIC)

 b. [... [DP PP [D' D [NP N t_{PP}]]]] (violates Anti-Locality)

It is the combination of these constraints that renders extraction from DP impossible. Equally, the presence of a DP layer in examples such as (81b) would also result in the same movement problem, with direct extraction of PP violating the PIC (83).

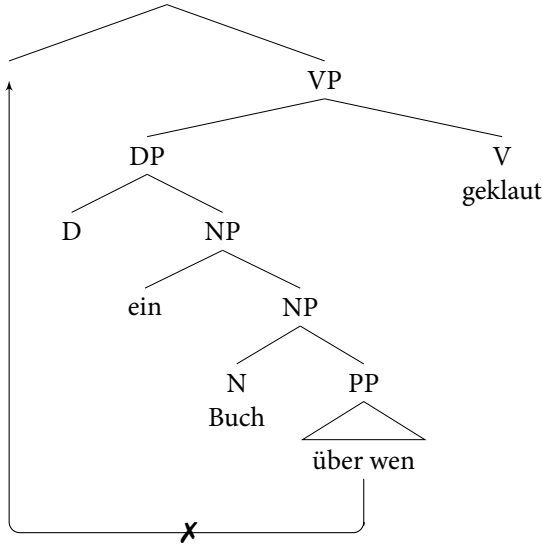
(83)



Where a predicate such as *schreiben*, which does allow for sub-extraction from its complement, differs from those not allowing extraction is that it can optionally bear a Remove feature [-D-]. This feature will lead to the object lacking a DP-layer.

(84) *Removal of DP shell:*

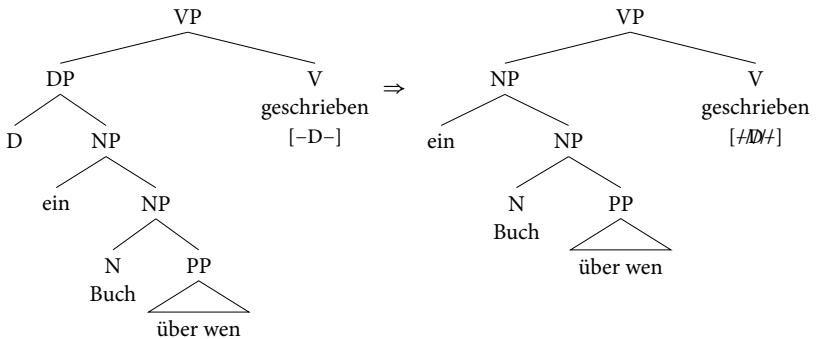

After Removal of DP, the conflict in (82) no longer exists (since there is no longer a phase) and direct extraction of the PP becomes possible (85), as in Slavic languages without a DP (Bošković 2005).

(85)

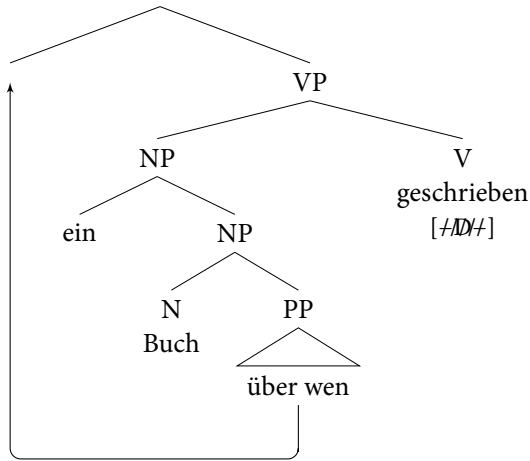

This approach suggests that [-D-] features are by no means restricted to clause-embedding predicates.

4.3. Nominal properties of moved clauses

Recall the puzzling fact from section 1 that the ‘traces’ of moved CPs seem to have the same distribution as nominals. In (86a), we see that CPs cannot ordinarily be the complement of a preposition. However, if this CP is moved, then the sentence becomes possible (86b). In other words, CP gaps seem to behave more like DP gaps.

(86) *CP gaps have nominal distribution* (Postal 1994:70):

- a. *I couldn’t convince Frank [PP of [CP that Sonia was very competent]]
- b. [CP That Sonia was very competent] I couldn’t convince Frank
[PP of —DP]

This has led to an analysis of moved CPs as ‘satellites’ (e.g. Emonds 1972, Koster 1978, Stowell 1981, Alrenga 2005, Moulton 2009, 2013). In other words, the CP itself does not move, but instead a null operator DP with which it is coindexed.

The Remove approach here offers an alternative approach to this puzzle. Let us assume that prepositions bear a Remove feature that can delete the DP shell on a clause in complement position only, in with the assumption in (48a).

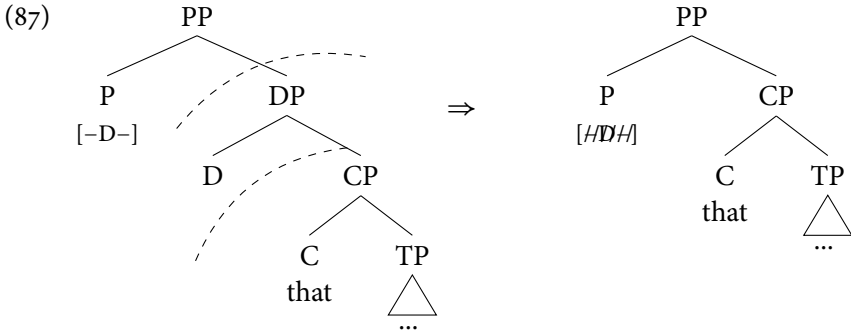

Furthermore, we will assume that the structure derived by Removal in (87) leads to a violation of the following PF filter:

(88) **P CP filter:*

A CP may not be the complement of a preposition to which it is PF-adjacent.

Evidence for this filter comes from what appear to category mismatches in coordination (Sag et al. 1985:165). In (89a), we have coordinated what appears to be a DP and CP, in violation of the ‘Law of Coordination of Likes’ (Neijt 1979, Sag et al. 1985). As we have seen, a preposition such as *on* cannot normally take a CP as its complement (89b). Furthermore, Bruening & Al Khalaf (to appear) show that reversing the order of the conjuncts in these examples results in ungrammaticality (89c).

- (89) a. You can depend on [_{DP} my assistant] and [_{CP} that he will be on time]
 b. *You can depend on [_{CP} that he will be on time]
 c. *You can depend on [_{CP} that my assistant will be on time] and [_{DP} his intelligence]

This means that, while there can be at least a surface mismatch in category under coordination, this is not possible if the CP is adjacent to the preposition. If we assume, as we did in section 3.4, that clauses are generated with a DP shell and this can be removed in an ATB-fashion in conjunctions, then the structure in (89c) will violate the filter in (88).

Furthermore, we see that the **P CP filter* can be circumvented by movement of the clause. Since we assume that it holds at PF, it is possible that moving the clause will result in the filter in (88) not being violated. This is what we see

when clauses that were originally complements to a preposition surface under ellipsis, i.e. in fragment answers (90b) and split questions (90c).

(90) *P+CP possible as fragments* (Merchant 2004:690; Arregi 2010:577):

- a. *I am ashamed [_{PP} of [_{CP} that I ignored you]]
- b. A: What are you ashamed of?
B: [_{CP} That I ignored you] ~~I am ashamed~~ [_{PP} of t_{CP}]
- c. What are you ashamed of, [_{CP} that you ignored me] ~~you are ashamed~~ [_{PP} of t_{CP}]?

Concretely, we assume that movement of the clause with its DP shell to the edge of the phase can be extrinsically-ordered so as to occur before Removal of DP. Since we have assumed that Removal of the DP shell is limited to complement position, successive-cyclic movement bleeds subsequent Structure Removal of D.

We can see this by returning to the original puzzle of why moved CP complements to prepositions are possible. We assume that PPs are universally phases and that P-stranding languages allow movement to the edge of PP phase (Abels 2012). For examples like (86), if a CP is fronted, it must first move to the phase edge (Spec-PP). Since Remove is feature driven, it can be extrinsically ordered after the edge feature ([•X•]) triggering intermediate movement to Spec-PP, as shown in (91).

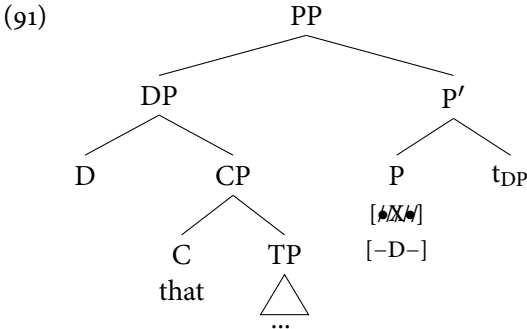

Now that the clause is in a specifier position, the DP shell can no longer be removed to check the [-D-] feature. Consequently, the trace/copy of the clause in its base-position is a DP, since Remove failed to apply. Thus, its nominal distribution can be accounted for.

As a point of cross-linguistic variation, it might be expected that other languages do not have this particular extrinsic ordering of Remove. In this case, Remove of the DP shell could apply before movement and we would expect that the copy/CP-trace would violate (90), if such a filter were also active in the language.

5. Conclusion

This paper has discussed clausal determiners in two Kwa languages: Akan and Gã. We have seen that the CD across these two languages has a rather complex syntactic distribution, surfacing in extraction contexts, with sentential subjects and certain types of conditional clauses. It was shown that this seemingly heterogeneous class of contexts is difficult to capture as the natural class of contexts in which the a DP can be added to a clause. Instead, we have argued that the contexts in which the CD can be realized constitute cases in which the DP shell inherent to clauses in the languages fails to undergo a process of syntactic Structure Removal. This alternative view of the CD's distribution unifies these contexts as those in which the clause occupies a non-complement position. We have suggested that, in Akan and Gã, feature-driven Structure Removal is only able to apply to constituents in complement position.

This analysis necessarily assumes that all clauses are born with a DP shell, what we might call the *Universal DP Shell Hypothesis*. Further evidence for this was provided from coordination. We saw that the coordinator in Akan can have a different morphological form (*ne*) when it coordinates nominals (i.e. DPs). Interestingly, this form is possible when full embedded clauses (including a complementizer) are conjoined, but not with simple TP coordination (where the coordinator is shared). This was argued to show that, at the point at which selection takes place, the clauses are actually DPs. They may lose this status by later Removal of the DP shells, however this comes too late to bleed satisfaction of the subcategorization requirements of *ne* (a case of counterbleeding opacity).

Finally, it was shown that the Structure Removal approach can be extended to some well-known puzzles from other languages. For example, assuming that Remove is subject to the Strict Cycle Condition, it can explain the otherwise puzzling connection between the islandhood and resistance to complementizer-drop found with clausal complements of both factive and manner-of-speaking verbs. Furthermore, it can provide an alternative account for why traces of

moved clauses have a nominal distribution. Also, it was argued that Removal of DP shells can also be extended to extraction from DP objects. An old puzzle is that some verbs easily license sub-extraction from their direct objects, while others do not. It was suggested that this arbitrary property of lexical predicates can be encoded as a Remove feature, removing the DP projection and, with it, the phase boundary. Future research should determine whether the Remove approach can shed further light on the DP/NP debate more generally (see e.g. Bošković 2008).

References

- Abels, Klaus (2003). *Successive Cyclicity, Anti-Locality and Adposition Stranding*. PhD thesis, University of Connecticut.
- Abels, Klaus (2012). *Phases: An Essay on Cyclicity in Syntax*. de Gruyter: Berlin.
- Aboh, Enoch O. (2004). *The Morphosyntax of Complement-Head Sequences: Clause Structure and Word Order Patterns in Kwa*. Oxford University Press: Oxford.
- Aboh, Enoch O. (2005). Deriving relative and factive clauses. In L. Bruge, G. Giusti, N. Munaro, W. Schweikert & G. Turano (eds). *Contributions to the 30th incontro di grammatical*. Libreria Editrice Cafoscarina: Venice. 265–285.
- Adams, Marianne (1985). Government of Empty Subjects in Factive Clausal Complements. *Linguistic Inquiry* 16(2). 305–313.
- Adger, David & Josep Quer (2001). The Syntax and Semantics of Unselected Embedded Questions. *Language* 77(1). 107–133.
- Alrenga, Peter (2005). A Sentential Subject Asymmetry in English and its Implications for Complement Selection. *Syntax* 8(3). 175–207.
- Arkoh, Ruby & Lisa Matthewson (2013). A Familiar Definite Article in Akan. *Lingua* 123. 1–30.
- Arregi, Karlos (2010). Ellipsis in Split Questions. *Natural Language and Linguistic Theory* 28(3). 539–592.
- Bach, Emmon & George M. Horn (1976). Remarks on “Conditions on Transformations”. *Linguistic Inquiry* 7(2). 265–299.
- Benz, Johanna (this volume). Structure Removal Counterfeeds Status Government. In A. Murphy (ed.). *Structure Removal*. Vol. 94. of *Linguistische Arbeits Berichte (LAB)*. Universität Leipzig: Leipzig.
- Biberauer, Theresa, Anders Holmberg & Ian Roberts (2014). A Syntactic Universal and its Consequences. *Linguistic Inquiry* 45(2). 169–225.
- Bošković, Željko (1995). Case Properties of Clauses and the Greed Principle. *Studia Linguistica* 49(1). 32–53.
- Bošković, Željko (2005). On the Locality of Left-Branch Extraction and the Structure of NP. *Studia Linguistica* 59(1). 1–45.

- Bošković, Željko (2008). What will you have, DP or NP?. In E. Elfner & M. Walkow (eds). *Proceedings of NELS 37*. GLSA: Amherst, MA. 101–115.
- Bošković, Željko & Howard Lasnik (2003). On the Distribution of Null Complementizers. *Linguistic Inquiry* 34(4). 527–546.
- Bruening, Benjamin & Eman Al Khalaf (to appear). Category Mismatches in Coordination Revisited. *Linguistic Inquiry*
- Chomsky, Noam (1973). Conditions on Transformations. In S. R. Anderson & P. Kiparsky (eds). *A Festschrift for Morris Halle*. Holt, Rinehart and Winston: New York. 232–286.
- Chomsky, Noam (1977). On Wh-Movement. In P. Culicover, T. Wasow & A. Akmajian (eds). *Formal Syntax*. Academic Press: New York. 71–132.
- Chomsky, Noam (2000). Minimalist Inquiries: The Framework. In R. Martin, D. Michaels, J. Uriagereka & S. J. Keyser (eds). *Step by Step: Essays on Minimalist Syntax in Honor of Howard Lasnik*. MIT Press: Cambridge, MA. 89–155.
- Chomsky, Noam (2001). Derivation by Phase. In M. Kenstowicz (ed.). *Ken Hale: A Life in Language*. MIT Press: Cambridge, MA. 1–52.
- Culicover, Peter W. & Ray Jackendoff (1997). Semantic Subordination Despite Syntactic Coordination. *Linguistic Inquiry* 28(2). 195–217.
- Davies, William D. & Stanley Dubinsky (1998). Sentential Subjects as Complex NPs: New Reasons for an Old Account of Subjacency. In M. C. Gruber, D. Higgins, K. S. Olson & T. Wysocki (eds). *Proceedings of CLS 34*. Chicago Linguistic Society: Chicago, IL. 83–94.
- Davies, William D. & Stanley Dubinsky (2001). Functional Architecture and the Distribution of Subject Properties. In W. D. Davies & S. Dubinsky (eds). *Objects and Other Subjects: Grammatical Functions, Functional Categories and Configurationality*. Kluwer: Dordrecht. 247–279.
- Davies, William D. & Stanley Dubinsky (2009). On the Existence (and Distribution) of Sentential Subjects. In D. B. Gerdts, J. C. Moore & M. Polinsky (eds). *Hypothesis A/Hypothesis B: Linguistic Explorations in Honor of David M. Perlmutter*. MIT Press: Cambridge, MA. 111–128.
- Delahunty, Gerald (1983). But Sentential Subjects Do Exist. *Linguistic Analysis* 12. 379–398.
- Elbourne, Paul (2001). E-Type Anaphora as NP-Deletion. *Natural Language Semantics* 9(3). 241–288.
- Emonds, Joseph E. (1972). A Reformulation of Certain Syntactic Transformations. In S. Peters (ed.). *Goals of Linguistic Theory*. Prentice-Hall: Englewood Cliffs, NJ. 21–61.
- Erteschik-Shir, Nomi (1973). *On the Nature of Island Constraints*. PhD thesis, MIT.
- Georgi, Doreen (2014). *Opaque Interactions of Merge and Agree: On the Nature and Order of Elementary Operations*. PhD thesis, Universität Leipzig.

- Grohmann, Kleanthes K. (2003). *Prolific Domains: On the Anti-Locality of Movement Dependencies*. John Benjamins: Amsterdam.
- Grubic, Mira & Agata Renans (2017). Definiteness Marking on VPs/TPs in Ga and Ngamo. In V. Hohaus & W. Rothe (eds). *Proceedings of TripleA 3*. Universität Tübingen: Tübingen. 1–15.
- Halpert, Claire & David Schueler (2013). That Sentential Subjects Are (Linked To) DPs is Explained Herein. *Snippets* 28. 9–10.
- Han, Hye Jin (2005). A DP/NP-shell for subject CPs. In R. T. Corver & Y. Kim (eds). *Proceedings of the 31st Annual Meeting of the Berkeley Linguistics Society*. Berkeley Linguistics Society: University of California, Berkeley. 133–143.
- Hankamer, Jorge & Line Mikkelsen (2012). CP Complements to D. Ms. University of California Santa Cruz.
- Hartman, Jeremy (2012). *Varieties of Clausal Complementation*. PhD thesis, MIT.
- Hein, Johannes (2017). Doubling and *do*-Support in Verbal Fronting: Towards a Typology of Repair Operations. *Glossa* 2(1). 67. 1–36.
- Hein, Johannes & Andrew Murphy (2018). VP Nominalization and the Final-over-Final Condition. Ms. Universität Potsdam & Universität Potsdam.
- Kastner, Itamar (2015). Factivity Mirrors Interpretation: The Selectional Requirements of Presuppositional Verbs. *Lingua* 164. 157–188.
- Kiparsky, Paul & Carol Kiparsky (1970). Fact. In M. Bierwisch & K. Heidolph (eds). *Progress in Linguistics: A Collection of Papers*. de Gruyter: The Hague. 143–173.
- Knyazev, Mikhail (2016). *Licensing Clausal Complements: The Case of Russian čto-Clauses*. PhD thesis, Utrecht University.
- Kobebe, Gregory M. & Harold Torrence (2004). The Syntax of Complement Clauses in Asante Twi. Ms. ULCA.
- Korsah, Sampson (2017). *Issues in Kwa Syntax: Pronouns and Clausal Determiners*. PhD thesis, Universität Leipzig.
- Korsah, Sampson & Andrew Murphy (to appear). Tonal Reflexes of Movement in Asante Twi. *Natural Language and Linguistic Theory*.
- Koster, Jan (1978). Why Subject Sentences Don't Exist. In S. J. Keyser (ed.). *Recent Transformational Studies in European Languages*. MIT Press: Cambridge, MA. 53–64.
- Kropp Dakubu, Mary E. (1992). Contrast in Context: Topic, Focus and Definiteness in Ga. *Journal of West African Languages* 22(2). 1–16.
- Kropp Dakubu, Mary Esther (2008). Ga Verb Features. In M. E. Ameka, Felix A. Kropp Dakubu (ed.). *Aspect and Modality in Kwa Languages*. John Benjamins: Amsterdam. 91–134.
- Larson, B. (2013). Varieties of Coordinated Questions in Twi. Presentation at the 44th Annual Conference on African Linguistics (ACAL), Georgetown University, Washington, DC. March 7–10, 2013.

- Lees, Robert (1960). *The Grammar of English Nominalizations*. Mouton: The Hague.
- Lefebvre, Claire (1992a). AGR in Languages Without Person and Number Agreement: The Case of the Clausal Determiner in Haitian and Fon. *Canadian Journal of Linguistics* 37(2). 137–156.
- Lefebvre, Claire (1992b). Towards a Typology of Predicate Cleft Languages. *Journal of West African Languages* 22(1). 53–61.
- Lohndal, Terje (2014). Sentential Subjects in English and Norwegian. *Syntaxe et Sémantique* 15. 81–113.
- McCawley, James D. (1984). Exploitation of the Cyclic Principle as a Research Strategy in Syntax. In W. de Geest & Y. Putseys (eds). *Sentential Complementation*. Foris: Dordrecht. 165–183.
- McCloskey, James (1991). *There, it* and Agreement. *Linguistic Inquiry* 22(3). 563–567.
- McCloskey, James (2002). Resumption, Successive Cyclicity, and the Locality of Operations. In S. Epstein & T. Seely (eds). *Derivation and Explanation in the Minimalist Program*. Blackwell: Oxford. 184–226.
- Merchant, Jason (2004). Fragments and Ellipsis. *Linguistics and Philosophy* 27(6). 661–738.
- Moulton, Keir (2009). *Natural Selection and the Syntax of Clausal Complementation*. PhD thesis, University of Massachusetts Amherst.
- Moulton, Keir (2013). Not Moving Clauses: Connectivity in Clausal Arguments. *Syntax* 16(3). 250–291.
- Moulton, Keir (2017). Determiners on Clauses. In N. LaCara, K. Moulton & A.-M. Tessier (eds). *A Schrift to Fest Kyle Johnson*. Linguistics Open Access Publications: Amherst, MA. 293–303.
- Müller, Gereon (1995). *A-bar Syntax: A Study in Movement Types*. de Gruyter: Berlin.
- Müller, Gereon (2017). Structure Removal: An Argument for Feature-Driven Merge. *Glossa* 2(1). 28. 1–35.
- Müller, Gereon (2018). Structure Removal in Complex Prefields. *Natural Language and Linguistic Theory* 36(1). 219–264.
- Müller, Gereon (this volumea). Long-Distance Passives by Structure Removal. In A. Murphy (ed.). *Structure Removal*. Vol. 94. of *Linguistische Arbeits Berichte (LAB)*. Universität Leipzig: Leipzig.
- Müller, Gereon (this volumeb). The Short Life Cycle of External Arguments in German Passive Derivations. In A. Murphy (ed.). *Structure Removal*. Vol. 94. of *Linguistische Arbeits Berichte (LAB)*. Universität Leipzig: Leipzig.
- Müller, Gereon (to appear). Rethinking Restructuring. In A. Bárány, T. Biberauer, J. Douglas & S. Vikner (eds). *Clausal Architecture and its Consequences: Synchronic and Diachronic Perspectives*. Language Science Press: Berlin.
- Müller, Gereon & Wolfgang Sternefeld (1995). Extraction, Lexical Variation and the Theory of Barriers. In U. Egli, P. E. Pause, C. Schwarze, A. von Stechow

- & G. Wienold (eds). *Lexical Knowledge in the Organization of Language*. John Benjamins: Amsterdam. 35–80.
- Murphy, Andrew (2016). Double Passivization in Turkish: A Structure Removal Approach. In K. Bellamy, L. Karvovskaya, M. Kohlberger & G. Saad (eds). *Proceedings of ConSOLE XXIII*. Leiden University Centre for Linguistics: . 316–339.
- Neijt, Anneke (1979). *Gapping: A Contribution to Sentence Grammar*. Foris: Dordrecht.
- Ormazabal, Javier (1995). *The Syntax of Complementation: On the Connection Between Syntactic Structure and Selection*. PhD thesis, University of Connecticut.
- Ormazabal, Javier (2005). The Syntactic Distribution of Factive Complements. *Recherches linguistiques de Vincennes* 33. 91–110.
- Osam, Emmanuel K. (1996). Animacy Distinctions in Akan Grammar. *Studies in the Linguistic Sciences* 23(2). 153–164.
- Partee, Barbara (1975). Montague Grammar and Transformational Grammar. *Linguistic Inquiry* 6(2). 203–300.
- Perlmutter, David M. & Scott Soames (1979). *Syntactic Argumentation and the Structure of English*. University of California Press: Berkeley, CA.
- Pesetsky, David (1991). Zero Syntax Vol. 2: Infinitives. Ms. MIT.
- Pesetsky, David (2019). Exfoliation: Towards a Derivational Theory of Clause Size. Ms. MIT. lingbuzz/004440.
- Picallo, M. Carme (2002). Abstract Agreement and Clausal Arguments. *Syntax* 5(2). 116–147.
- Pietraszko, Asia (2019). Obligatory CP Nominalization in Ndebele. *Syntax* 22(1). 66–111.
- Postal, Paul M. (1994). Parasitic and Pseudoparasitic Gaps. *Linguistic Inquiry* 25(1). 63–117.
- Postal, Paul M. & Geoffrey K. Pullum (1988). Expletive Noun Phrases in Subcategorized Positions. *Linguistic Inquiry* 19(4). 635–670.
- Potts, Christopher (2002). The Lexical Semantics of Parenthetical-*as* and Appositive-*which*. *Syntax* 5(1). 55–88.
- Pullum, Geoffrey K. (1979). *Rule Interaction and the Organization of a Grammar*. Garland: New York.
- Renans, Agata (2016). *Exhaustivity: On exclusive particles, clefts and progressive aspect in Ga (Kwa)*. PhD thesis, Universität Potsdam.
- Rizzi, Luigi (1997). The Fine Structure of the Left Periphery. In L. Haegeman (ed.). *Elements of Grammar*. Kluwer: Dordrecht. 281–337.
- Rosenbaum, Peter (1967). *The Grammar of English Predicate Complement Constructions*. MIT Press: Cambridge, MA.
- Ross, John R. (1967). *Constraints on Variables in Syntax*. PhD thesis, MIT.
- Ross, John R. (1986). *Infinite Syntax!*. Ablex Publishing: Norwood.

- Roussou, Anna (1991). Nominalized Clauses in the Syntax of Modern Greek. *UCL Working Papers in Linguistics* 3. 77–100.
- Saah, Kofi K. (1994). *Studies in Akan Syntax, Acquisition and Sentence Processing*. PhD thesis, University of Ottawa.
- Saah, Kofi K. (2010). Relative Clauses in Akan. In E. O. Aboh & J. Essegbey (eds). *Topics in Kwa Syntax*. Springer: Dordrecht. 91–109.
- Saah, Kofi K. & Helen Goodluck (1995). Island Effects in Parsing and Grammar: Evidence from Akan. *The Linguistic Review* 12(4). 381–409.
- Sag, Ivan A., Gerald Gazdar, Thomas Wasow & Steven Weisler (1985). Coordination and How to Distinguish Categories. *Natural Language and Linguistic Theory* 3(2). 117–171.
- Salzmann, Martin (2017). *Reconstruction and Resumption in Indirect A'-Dependencies: On the Syntax of Prolepsis and Relativization in (Swiss) German and Beyond*. de Gruyter: Berlin.
- Schwarzer, Marie-Luise (this volume). *Tough-Displacement without Movement*. In A. Murphy (ed.). *Structure Removal*. Vol. 94. of *Linguistische Arbeits Berichte (LAB)*. Universität Leipzig: Leipzig.
- Sheehan, Michelle, Theresa Biberauer, Ian Roberts & Anders Holmberg (2017). *The Final-Over-Final Condition: A Syntactic Universal*. MIT Press: Cambridge, MA.
- Sheehan, Michelle & Wolfram Hinzen (2011). Moving Towards the Edge. *Linguistic Analysis* 37(3–4). 405–458.
- Stowell, Tim (1981). *Origins of Phrase Structure*. PhD thesis, MIT.
- Takahashi, Shoichi (2010). The Hidden Side of Clausal Complements. *Natural Language and Linguistic Theory* 28(2). 343–380.
- van Urk, Coppe (2015). *A Uniform Syntax for Phrasal Movement: A Case Study of Dinka Bor*. PhD thesis, MIT.
- Vergnaud, Jean-Roger (1977/2008). Letter to Noam Chomsky and Howard Lasnik on “Filters and Control”, April 17, 1977. In R. Freidin, C. P. Otero & M. L. Zubizarreta (eds). *Foundational Issues in Linguistic Theory: Essays in Honor*. MIT Press: Cambridge, MA. 3–15.
- Weisser, Philipp (2015a). *Derived Coordination: A Minimalist Perspective on Clause Chains, Converbs and Asymmetric Coordination*. de Gruyter: Berlin.
- Weisser, Philipp (2015b). The Syntactic Side of Conditional Conjunction. *Lingua* 153. 42–65.
- Zoerner, Cyril Edward (1995). *Coordination: The Syntax of &P*. PhD thesis, University of California, Irvine.
- Zyman, Erik (2018). Super-Local Remove in Nominal Preposing Around *Though*. *Snippets* 33. 13–15.